

# TREVIFORM

**TREVIL**

INNOVATION FOR YOU



## The new Treviform, always a step ahead

Tensioning form finisher with 360° form rotation and touch screen control.  
Now available with built-in boiler.

## TREVIFORM

### Jackets

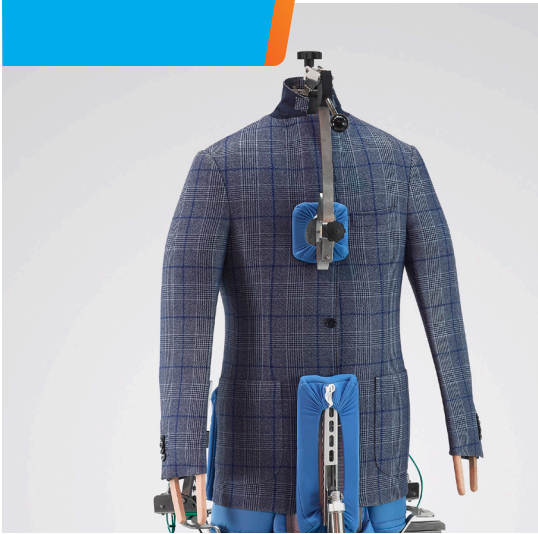

### Dresses



The ultimate form finisher for all types of garments for the upper body.

The Treviform finishes any type of fabric.

Garment tensioning can be precisely adjusted. Gentle tension respects garments made of delicate fabric, or with a spandex content.

Washed and wetcleaned items can be restored in shape using stronger tensions.

### Coats



### Casual jackets

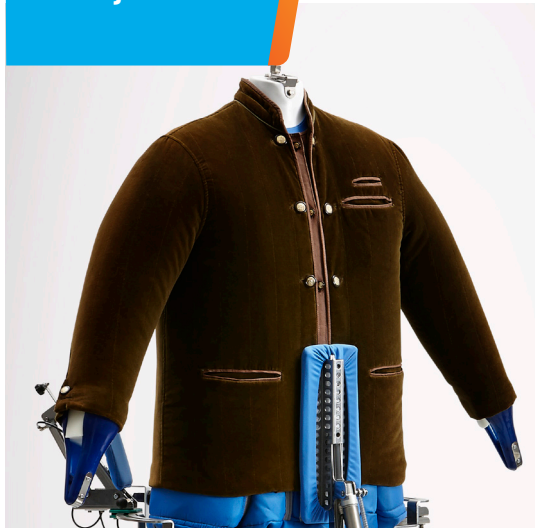

### Small size or fitted ladies jackets



### Leather garments



Available with boiler



Now available with automatic boiler built into the cabinet.

Compact size

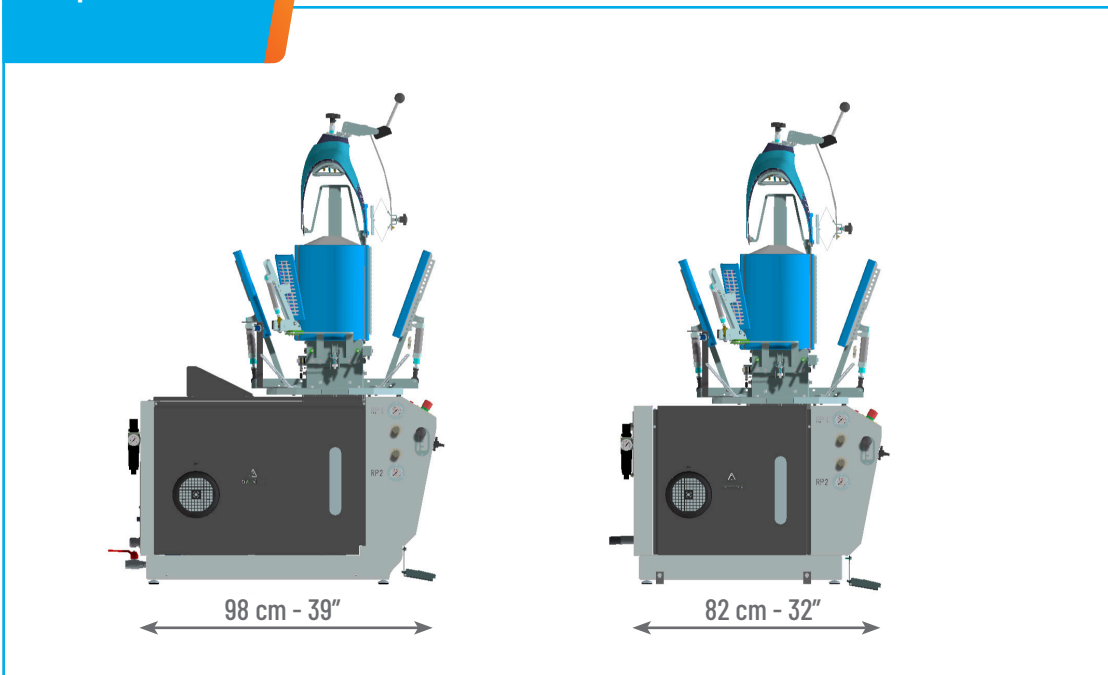

Both versions, with or without boiler, are extremely compact.



### Responsive touch screen



The touch screen uses the same technology as most advanced smartphones for an immediate response to your touch.

### Intuitive interface



The SMART interface is extremely user-friendly and puts all necessary controls right at your fingertips.

### Easy troubleshooting

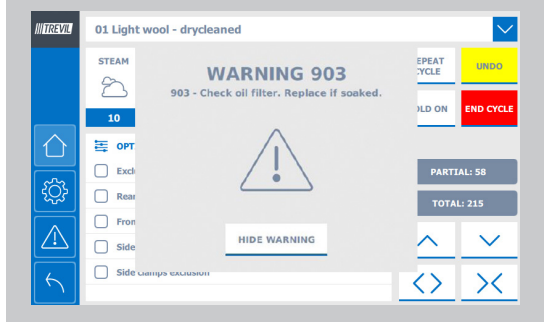

Error messages and maintenance reminders pop ups are written in a natural language that makes it easy to identify and report issues.

### Complete form rotation



The form makes a full rotation for easier dressing and for touch ups during the cycle.

### Adjustment of blowing strength



Manual adjustment (standard)



Electronic adjustment (option)

Automatic height adjustment

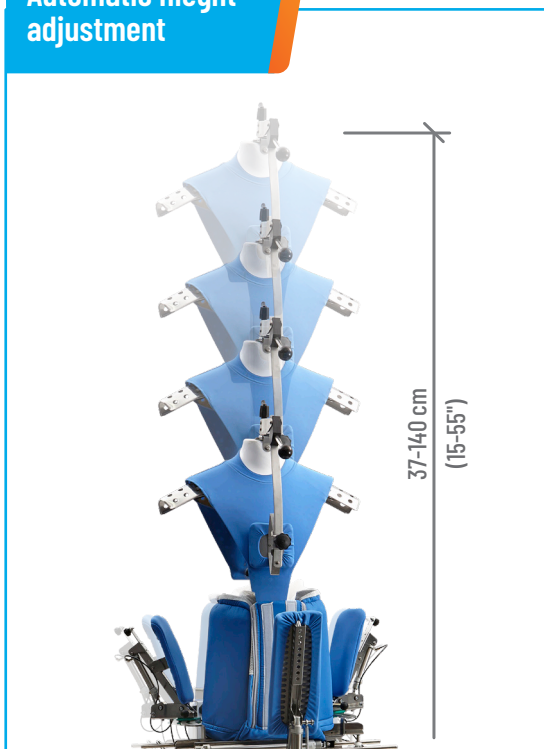

The form adjusts automatically its height using a photocell. The movement uses an oil cylinder for precise positioning and firm traction.

Shoulders width adjustment



Shoulder width can be adjusted in a range that covers most sizes of men's and women's clothing.

Removable lapel clamp

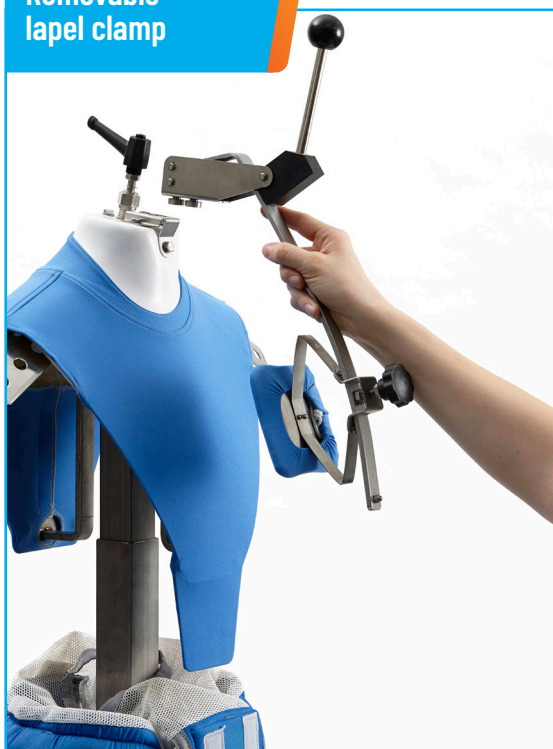

The front clamp is removable for garments closed on the front, or with a front zipper.

Accurate pressure adjustment



The pressure of different set of clamps can be easily and independently adjusted.

6 clamps configuration



Clamps for side vents are included, an additional pair of side clamps is available as an option for a firmer hold of leather or windproof garments.

Included sleeve expanders

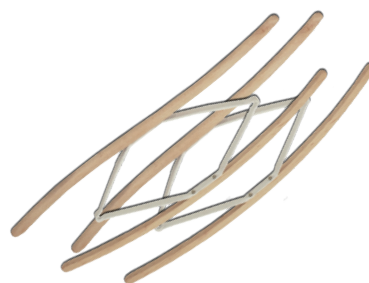

Optional accessories



INNOVATION FOR YOU

Trevil s.r.l. - Via Copernico, 1 - 20060 Pozzo d'Adda (MI) - Italy  
 Tel. +39 02 9093141 - [www.trevil.com](http://www.trevil.com) - [info@trevil.com](mailto:info@trevil.com)